



# Instruction Manual

## PopMaxx 12/14 oz. Popper

Model No. 2552, 2552KC



**GOLD MEDAL<sup>®</sup> PRODUCTS CO.**

10700 Medallion Drive, Cincinnati, Ohio 45241-4807 USA

# SAFETY PRECAUTIONS

	<b>⚠ DANGER</b>
	<p>Machine must be properly grounded to prevent electrical shock to personnel. Failure to do so could result in serious injury, or death. DO NOT immerse any part of this equipment in water. DO NOT use excessive water when cleaning. Keep cord and plug off the ground and away from moisture. Always unplug the equipment before cleaning or servicing. Make sure all machine switches are in the OFF position before plugging the equipment into the receptacle.</p> <p>008_051514</p>

	<b>⚠ DANGER</b>
	<p>Improper installation, adjustment, alteration, service, or maintenance can cause property damage, injury, or death. Any alterations to this equipment will void the warranty and may cause a dangerous condition. This appliance is not intended to be operated by means of an external timer or separate remote-control system. NEVER make alterations to this equipment. Read the Installation, Operating, and Maintenance Instructions thoroughly before installing, servicing, or operating this equipment.</p> <p>014_020416</p>

	<b>⚠ WARNING</b>
	<p>To avoid burns, DO NOT touch the kettle or any heated surface. DO NOT place or leave objects in contact with heated surfaces.</p> <p>013_092414</p>



	<b>⚠ WARNING</b>
	<p>ALWAYS wear safety glasses when servicing this equipment.</p> <p>010_010914</p>



	<b>⚠ WARNING</b>
	<p>No user serviceable parts inside. Refer servicing to qualified service personnel.</p> <p>011_051514</p>

	<b>⚠ WARNING</b>
	<p>Read and understand operator's manual and all other safety instructions before using this equipment. To order copies of the operator's manual go to <a href="http://gmpopcorn.com">gmpopcorn.com</a> or write to Gold Medal Products Co., 10700 Medallion Drive, Cincinnati, OH 45241 USA 1-(800)-543-0862</p> <p>022_060215</p>



## SAFETY PRECAUTIONS (continued)

	 <b>WARNING</b>
	DO NOT allow direct contact of this equipment by the public when used in food service locations. Only personnel trained and experienced in the equipment operation may operate this equipment. Carefully read all instructions before operation. <span style="float: right;">012_010914</span>

	 <b>WARNING</b>
	This machine is NOT to be operated by minors. <span style="float: right;">007_010914</span>

**Note:** Improvements are always being made to Gold Medal's equipment. This information may not be the latest available for your purposes. It is critical that you call Gold Medal's Technical Service Department at 1-800-543-0862 for any questions about your machine operations, replacement parts, or any service questions. (Gold Medal Products Co. does not assume any liability for injury due to careless handling and/or reckless operation of this equipment.)



# INSTALLATION INSTRUCTIONS

## Inspection of Shipment

After unpacking, check thoroughly for any damage which may have occurred in transit. Claims should be filed immediately with the transportation company. The warranty does not cover damage that occurs in transit, or damage caused by abuse, or consequential damage due to the operation of this machine, since it is beyond our control (reference warranty in back of manual).

## Manual

Read and understand the operator's manual and all other safety instructions before using this equipment. To order copies of the operator's manual go to [gmpopcorn.com](http://gmpopcorn.com) or write to Gold Medal Products Co., 10700 Medallion Drive, Cincinnati, OH 45241 USA 1-(800)-543-0862.

## Model Description

**2552:** 12/14 oz. PopMaxx Popper, with Popcorn Decal.

**2552KC:** 12/14 oz. PopMaxx Popper with Pappy's Decal, and special kettle for popping Pappy's Kettle Corn.

## Items Included with this Unit

**Aluminum Scoop**

**Measure 14.7 cc**

**Measure 1/2 Cup**

**12 oz. Corn Measure**

**Bulb for Cabinet Interior**

**Knobs with Tee Bolts (for Popper Doors)**

**Knob with Screw (for Old Maid Pan)**

**Black Crutch Tips**

**Popcorn Decal (2552 only)**

**Salt Shaker (2552KC only)**

**Timer (2552KC only)**

**Pappy's Instruction Labels (2552KC only)**

**Pappy's Label (2552KC only)**

**PAPPY'S OPEN KETTLE CORN POPPING SUGGESTIONS**

**CAUTION: FRESH POPCORN IS EXTREMELY HOT TO COOL BEFORE SERVING.**

**1. ADD SALT AFTER THE CORN IS POPPED, DO NOT ADD SALT TO THE CORN BEFORE IT STARTS TO POP.**

**2. FOR THE LAST BATCH OF CORN, TURN OFF THE POPPER WHEN THE CORN STARTS TO POP. A CLEAN KETTLE. USE 2000 HEAT KLEEN FOAM TO CLEAN THE KETTLE.**

**3. DUMP KETTLE WHEN POPPING IS DONE. DO NOT TOUCH THE KETTLE UNTIL IT IS COOL TO THE TOUCH. POP AT RISK.**

**PAPPY'S KETTLE CORN & CARAMEL RICE POPPING INSTRUCTIONS**

**1. Turn KETTLE HEAT, 875W MOTOR and LIGHTS "ON".**

**2. FIRST BATCH ONLY: Pre-heat kettle for 4 Minutes. (Do not touch kettle until 4 minutes are over. PAPPY NO SALT!) Set timer for 02 to 05 Minutes.**

**3. COOK CORN THREE INSTRUCTIONS**

**1. Press 80W & SEC together to reset timer to zero.**

**2. Use 80W & SEC buttons to set time.**

**3. Press START button to start or stop.**

**4. The alarm will sound for 30 Sec. or longer and may be stop alarm. The timer will return to the set time.**

## Setup

This unit has been tested at the factory.



1. Remove all packaging and tape prior to operation. Remove accessories and carefully remove kettle packed in cabinet interior.
2. Place unit on a sturdy, level base.
3. The Popper blower vents out top of unit, allow adequate clearance for airflow.
4. Unit has 4 glide feet preinstalled at the factory (see image below). Install a Black Crutch Tip on each foot. Firmly push crutch tip over glide until it covers glide entirely.
5. Tilt kettle and insert into hanger arms, then allow kettle to return naturally to an upright position (see image below).
6. Plug kettle lead into receptacle located on ceiling of cabinet interior. Align keyed or hook shaped prong with the correct opening, then push plug all the way in and twist or rotate to lock in place. To unplug, untwist kettle plug before attempting to pull from receptacle.
7. Door knobs are shipped in accessories pack. Install a door knob with tee bolt on each popper door; install knob with screw on old maid pan.
8. Carefully install light bulb (do not over-tighten) into lamp holder located in cabinet interior. Ensure unit is OFF and unplugged before installing or changing bulb (reference Electrical Requirements section).
9. Apply Popcorn decal to unit.
10. Model 2552KC - Mount Timer (use Velcro provided) and Instruction Labels to popper in desired locations.
11. After setup, unit should be cleaned prior to use (see Care and Cleaning section).



## Electrical Requirements

The following power supply must be provided:

2552, 2552KC: 120 V~, 1380 W, 60 Hz

	 <b>DANGER</b>
	<p>Machine must be properly grounded to prevent electrical shock to personnel. Failure to do so could result in serious injury, or death. DO NOT immerse any part of this equipment in water. DO NOT use excessive water when cleaning. Keep cord and plug off the ground and away from moisture. Always unplug the equipment before cleaning or servicing. Make sure all machine switches are in the OFF position before plugging the equipment into the receptacle.</p> <p>008_051514</p>

A certified electrician must furnish sufficient power for proper machine operation and install any supplied receptacle. We recommend this equipment be on a dedicated and protected circuit. Failure to wire properly will void the warranty and may result in damage to the machine. It is Gold Medal Products Co.'s recommendation that this machine be plugged directly into a wall outlet. The use of extension cords is not recommended due to safety concerns, and may cause sacrificed and/or reduced performance. Make sure cord is located to prevent a trip hazard or unit upset.

## Before You Plug In Machine

1. Make sure all machine switches are OFF before plugging equipment into receptacle.
2. Make sure wall outlet can accept the grounded plugs (where applicable) on the power supply cord.
3. The wall outlet must have the proper polarity. If in doubt, have a competent electrician inspect the outlet and correct if necessary.
4. **DO NOT** use a grounded to un-grounded receptacle adapter (where applicable).
5. Install unit in a level position.

	 <b>CAUTION</b>
	<p>If the supply cord is damaged, it must be replaced by Gold Medal Products Co., its service agent or similarly qualified persons in order to avoid a hazard.</p> <p>039_080614</p>

# OPERATING INSTRUCTIONS

## Controls and Their Functions

### KETTLE HEAT SWITCH

Two position, ON/OFF lighted rocker switch - supplies power to the heating elements in the popping kettle. The green switch light ON indicates there is power to the kettle heating element.

### KETTLE MOTOR SWITCH

Two position, ON/OFF lighted rocker switch - supplies power to the kettle agitator motor and exhaust blower. The Kettle Motor Switch **MUST** be ON at all times when there is popcorn (popped or un-popped) in the kettle. The green switch light ON indicates there is power to the agitator motor and exhaust blower.

### LIGHTS/WARMER SWITCH

Two position, ON/OFF lighted rocker switch - supplies power to the interior cabinet light, and heat element for the corn pan.

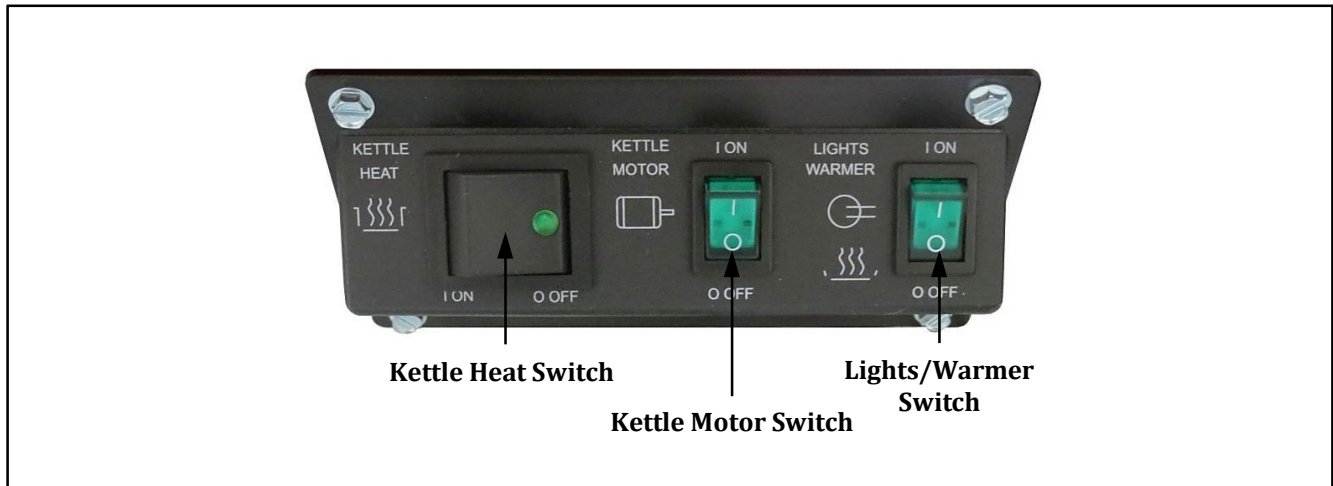



# Popping Corn Instructions

This section describes instructions for popping Standard (salted) popcorn, and for popping Pappy's Kettle Corn.

## Amount of Popcorn and Oil

The popper is equipped with a corn, salt, and oil measure. We recommend flavored and colored coconut oil. Popcorn popped in coconut oil stays fresh longer and does not leave black deposits in the kettle like other oils. Use only top quality, fresh popcorn from reputable suppliers.

Kettle Size	Popcorn Charge	Oil Charge	Flavacol (Salt)
12 oz.	12 oz. (355 ml)	4 oz. (118 ml)	1 Tbsp. (15cc)

For best results use Mega-Pop® 12 oz. premeasured pouches (Item# 2839).

## Popping Standard (Salted) Popcorn

1. Turn all switches ON.
2. To determine when kettle is ready to pop corn (about 4 minutes), test pop three kernels of corn in one ounce (30 ml) of popping oil. When kernels pop, kettle is ready.
3. Lift kettle lid and load Mega-Pop® premeasured popcorn and oil pouch, or pour in popcorn and Flavacol, then add oil in premeasured amount. Close lid.
4. When corn has finished popping, gently dump the popcorn.
5. On final kettle of corn, turn Kettle Heat Switch OFF just as lids are forced open by the popping corn. This procedure saves electricity, since kettle has plenty of heat, and helps eliminate smoke/odor from any oil residue that remains after popping has stopped.
6. When finished popping, turn KETTLE HEAT and KETTLE MOTOR switches OFF.

**NEVER LEAVE THE HEAT ON WHEN YOU ARE NOT POPPING CORN!**





## Popping Pappy's Kettle Corn (Timer included with Unit)

**Items needed:** Popcorn, oil, Pappy's Kettle Corn Mix (Item No. 2545CT, 1/2 gallon container), and Diamond Crystal Popcorn Salt (Item No. 2070CT, 12 oz. container). **DO NOT** use popcorn seasoning salt when popping Pappy's Kettle Corn.

Gold Medal recommends white coconut oil for popping Pappy's Kettle Corn (colored oil can change the popcorn color). Popcorn popped in coconut oil stays fresh longer and does not leave black deposits in the kettle like other oils. Use only top quality, fresh popcorn from reputable suppliers.

Kettle Size	Popcorn Amount	Oil Amount	Pappy's Mix Amount
12 oz.	12 oz.	5 oz.	7-8 oz.

1. Turn all switches ON.
2. To determine when kettle is ready to pop corn (about 4 minutes), test pop three kernels of corn in one ounce (30 ml) of popping oil. When kernels pop, kettle is ready.
3. Lift kettle lid and pour in popcorn and oil (use amounts specified above, adjust as needed for desired taste). **DO NOT** add Salt (salt is added *after* popping). Close lid.
4. Start timer, pre-set for 30-45 seconds (see Countdown Timer Instructions below).
5. When timer goes OFF, add Pappy's Mix to kettle (use amount specified above). If popping has just started, close the right door of popper cabinet, and carefully/quickly add Pappy's mix through the left door. Close kettle lid, then re-open the right door.  
**Caution:** Due to the potential of getting hit with hot popcorn seeds, we recommend using eye protection for this step.
6. When the corn has nearly finished popping, gently dump the popcorn.
7. Immediately shake on Diamond Crystal Salt and mix thoroughly.
8. On final kettle of corn, turn Kettle Heat Switch OFF just as lids are forced open by the popping corn. This procedure saves electricity, since kettle has plenty of heat, and helps eliminate smoke/odor from any oil residue that remains after popping has stopped.
9. When finished popping, turn KETTLE HEAT and KETTLE MOTOR switches OFF.  
**NEVER LEAVE THE HEAT ON WHEN YOU ARE NOT POPPING CORN!**
10. Clean kettle when finished popping kettle corn, and prior to popping standard popcorn.

## Countdown Timer Instructions

1. Press MIN and SEC together to reset timer to zero.
2. Use MIN and SEC buttons to set time.
3. Press START button to start or stop.
4. The alarm will sound for 60 seconds or press any key to stop alarm. The timer will return to the set time.

## Care and Cleaning

	<b>⚠ DANGER</b>
	<p>Machine must be properly grounded to prevent electrical shock to personnel. <b>DO NOT immerse in water.</b> Always unplug the equipment before cleaning or servicing.</p> <p style="text-align: right;">025_020314</p>

	<b>⚠ WARNING</b>
	<p>To avoid serious burns, <b>DO NOT</b> touch the kettle while it is hot!</p> <p style="text-align: right;">028_082715</p>

Good sanitation practice demands that all food preparation equipment be cleaned regularly (only use non-toxic, food grade cleaners). A clean looking, well-kept machine is one of the best ways of advertising your product.

**Note:** It is extremely important to follow all of the cleaning procedures, otherwise parts damage and equipment failure will result. The warranty does not cover parts that are damaged due to improper cleaning.

### Daily Kettle Cleaning Instructions

**CAUTION:** A hot kettle will cause burns if you touch it with your hand. Allow kettle to cool at least 1 hour before attempting to clean. **DO NOT** use ice or water to cool down a hot kettle! Severe kettle damage will result!

1. When cool, wipe the **outside** of the kettle with a clean, soft cloth. **DO NOT** use oven cleaners or abrasive materials as they will damage the kettle.
2. Every night, mix Gold Medal's Heat'n Kleen solution (Item No. 2095), 2 tablespoons per gallon of water. It is not necessary to use the entire gallon at once; only use enough to fill the kettle 1/2 inch deep.
3. Turn the kettle heat ON. When the water starts to boil, turn the kettle heat OFF.
4. Allow to cool for at least 1 hour, then dump the solution into a bucket and wipe the inside of the kettle with a clean cloth. Make sure all of the solution goes into the bucket; do not spill any in the interior of the machine.

For an extra dirty kettle, the process may be repeated; or, after turning the kettle heat OFF, allow solution to sit in the kettle overnight. The next morning, dump the solution into a bucket and wipe the inside of the kettle with a clean cloth.

5. With the unit OFF and unplugged, wipe the kettle lead cord with a clean SLIGHTLY damp cloth. **DO NOT get moisture into the kettle lead-in cord, severe damage will result.**

## Daily Unit Cleaning Instructions

1. Turn machine OFF, unplug unit and allow it to cool before attempting to clean.
2. Clean all pans/accessories in order to sanitize them before each use.
3. Take a clean, SLIGHTLY damp cloth and wipe excess grease from glass and cabinet.
4. Wipe stainless steel parts with a clean cloth and cleaner designed for stainless steel, such as Gold Medal Watchdog Stainless Cleaner (Item No. 2088).

**DO NOT** use oven cleaners or abrasive materials as they will damage parts of machine.

5. Clean glass panels with glass cleaner. Gold Medal Watchdog Glass Cleaner (Item No. 2588) is recommended.

Ammonia cleaners will damage plastic doors/panels. Use only non-ammonia cleaners, such as Gold Medal Watchdog Glass Cleaner (Item No. 2588).

## Filter Cleaning Instructions

The popcorn machine is equipped with an efficient and durable filtration system. The filter should be cleaned every 1-2 weeks to maintain maximum efficiency.

### Steps to Clean Filter

**Step 1:** Turn unit OFF and allow it to cool before removing filter. Filter is located inside the popcorn machine, above the popping kettle.

**Step 2:** Remove filter by gripping the filter itself and pulling straight down.

**Step 3:** Clean filter in warm soapy water, then rinse and allow to dry overnight. Replace filter by putting it into the slot and pushing upward. Make sure the filter frame is flush with the ceiling of the popper (as shown above).

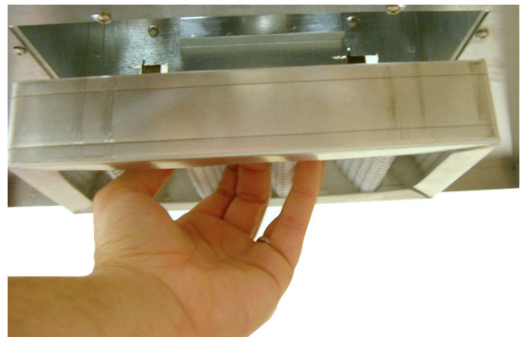
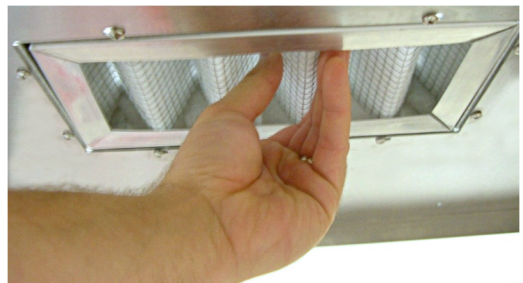
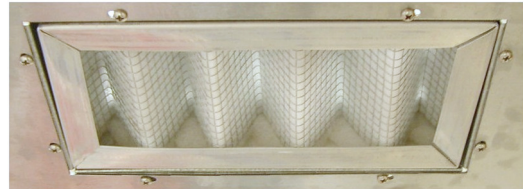



# Troubleshooting

Issue	Possible Cause	Solution
<b>Power to the Unit</b>	A. Power to the Unit	A. Make sure the unit's power cord is plugged in.
<b>Kettle Does Not Heat</b>	A. Power to the Kettle B. Kettle Heat Switch C. Heating Element	A. Make sure kettle lead-in cord is plugged in and twisted to lock into the kettle receptacle. B. Have a qualified service person check the voltage to and from the Kettle Heat Switch; if switch is defective, replace it. C. Heating element in the kettle may be burned out. Check with a qualified service person for inspection/repair.
<b>Long Popping Cycles</b> (Longer than 4 minutes for Salt Popcorn)	A. Low Voltage B. Inadequate Supply Lines C. Inferior Corn	A. If the machine is operated on low voltage, this could cause the kettle not to reach the proper operating temperature. Check with a qualified electrician. B. Inadequately sized electrical supply lines or use of extension cord, in addition to being a fire hazard, would also prevent the kettle from reaching the proper operating temperature. Check with a qualified electrician. C. Inferior quality corn would result in longer popping cycles. Use only top quality hybrid popcorn from reputable suppliers. Even then, if you let your corn pick up moisture or dry out, your popping cycles will be slow.
<b>Kettle Agitator Shaft not Rotating</b>	A. Kettle Motor Switch B. Kettle Agitator Shaft/Stir Blade not rotating. <b>(Unit must be OFF, unplugged and cool prior to checking or adjusting the agitator assembly.)</b>	A. If the kettle agitator shaft is not rotating, <b>DO NOT</b> pop corn. Make sure the Kettle Motor Switch is ON. If the switch is ON, and the shaft is not rotating, the switch or motor may be faulty, contact qualified service personnel for inspection/repair. B. If the kettle agitator shaft is not rotating, <b>DO NOT</b> pop corn. Check the clearance between the kettle bottom and the stir blade; it should be 1/32" (use a dime). To adjust, reference the Agitator Set Collar Adjustment section.

# Agitator Set Collar Adjustment

The following instructions describe how to properly adjust set collars on an agitator assembly with a floating stir rod.

## Steps to Adjust Set Collars

**Step 1:** Make sure machine is OFF and unplugged, then allow unit to cool completely before attempting to adjust the agitator height.

**Step 2:** Loosen the set screw in each set collar to be adjusted.

**Step 3:** With the kettle mounted in the popper, adjust the shaft so the Agitator's Spur Gear contacts half of the Drive Motor Spur Gear (reference Spur Gear Placement image at right). **DO NOT** set spur gears at full gear contact; it can cause binding as the kettle is dumped.

**Step 4:** Once shaft is positioned correctly, re-tighten the set screw in the set collar above the crossbar to secure in place.

**Step 5:** Adjust clearance between the bottom of the crossbar and the lower set collar to 1/32" (thickness of a dime); then re-tighten set screw to secure in place (see image below).

**Step 6:** Adjust set collar for agitator weight to be between 3/16" to 1/4" above the agitator weight. Once adjusted, re-tighten set screw to secure in place.

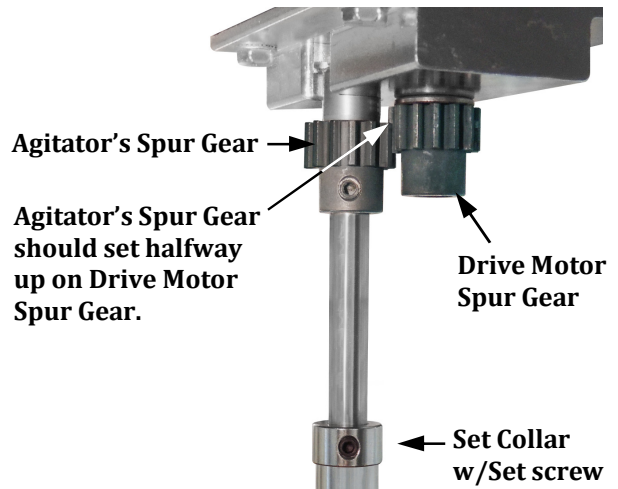

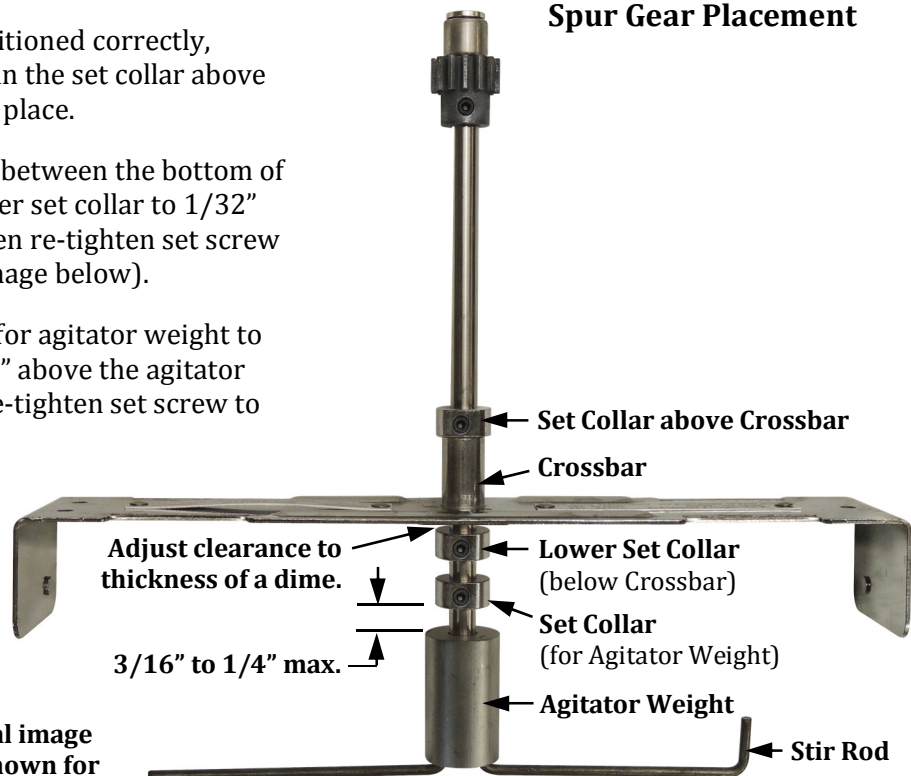

Spur Gear Placement







Agitator shown for general image reference only (lids not shown for clarity).





# MAINTENANCE INSTRUCTIONS

	 <b>DANGER</b>
	<p>Machine must be properly grounded to prevent electrical shock to personnel. Failure to do so could result in serious injury, or death. DO NOT immerse any part of this equipment in water. DO NOT use excessive water when cleaning. Keep cord and plug off the ground and away from moisture. Always unplug the equipment before cleaning or servicing. Make sure all machine switches are in the OFF position before plugging the equipment into the receptacle.</p> <p>008_051514</p>

	 <b>DANGER</b>
	<p>Improper installation, adjustment, alteration, service, or maintenance can cause property damage, injury, or death. Any alterations to this equipment will void the warranty and may cause a dangerous condition. This appliance is not intended to be operated by means of an external timer or separate remote-control system. NEVER make alterations to this equipment. Read the Installation, Operating, and Maintenance Instructions thoroughly before installing, servicing, or operating this equipment.</p> <p>014_020416</p>

	 <b>WARNING</b>
	<p>No user serviceable parts inside. Refer servicing to qualified service personnel.</p> <p>011_051514</p>

	 <b>CAUTION</b>
	<p>THE FOLLOWING SECTIONS OF THIS MANUAL ARE INTENDED ONLY FOR QUALIFIED SERVICE PERSONNEL WHO ARE FAMILIAR WITH ELECTRICAL EQUIPMENT. THESE ARE NOT INTENDED FOR THE OPERATOR.</p> <p>027_010914</p>



---

## ORDERING SPARE PARTS

1. Identify the needed part by checking it against the photos, illustrations, and/or parts list.
2. Use only approved replacement parts when servicing this unit.
3. When ordering, please include part number, part name, and quantity needed.
4. Please include your model number, serial number, and date of manufacture (located on the machine nameplate/data plate) with your order.
5. Address all parts orders to:

Parts Department  
Gold Medal Products Co.  
10700 Medallion Drive  
Cincinnati, Ohio 45241-4807

Or, place orders by phone or online:

Phone: (800) 543-0862  
(513) 769-7676  
Fax: (800) 542-1496  
(513) 769-8500  
E-mail: [info@gmpopcorn.com](mailto:info@gmpopcorn.com)  
Web Page: [gmpopcorn.com](http://gmpopcorn.com)

## Replacing Broken Glass

Broken glass panels can be easily replaced. Gold Medal Products Co. does not ship glass. It can be obtained from a local glass shop, always purchase tempered glass.

### GLASS DIMENSIONS (Height x Width x Thickness)

**Front and Side Glass:** 21 1/4" X 16 7/8" X 1/8" (3 Pieces)

1. With the machine OFF, unplug the unit and allow it to cool before attempting to replace any glass.
2. Carefully remove all loose pieces of broken glass.
3. Pull out Magnetic Clip (located above glass panel in cabinet interior) to remove (see Figure A below).
4. Slide glass panel up under top ridge, then swing the bottom of the panel out and lower it away from unit (see Figures A and B below).
5. Carefully remove the rest of the broken glass.
6. Remove all rigid glass channels from around the glass to be replaced, set channels aside for reuse.
7. Apply decals (if desired) to the new glass panel.
8. Slide rigid glass channels over the exposed edges of the new glass panel.
9. Carefully slide new glass panel up under top ridge, then lower it into the bottom channel.
10. Reinstall magnetic clip above the new panel in cabinet interior.

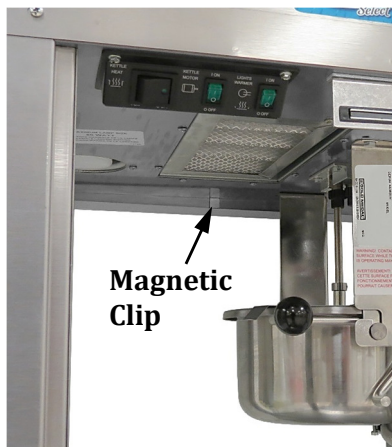

**Figure A** - Remove magnetic clip located above glass panel.



**Figure B** - Slide glass panel up under top ridge.

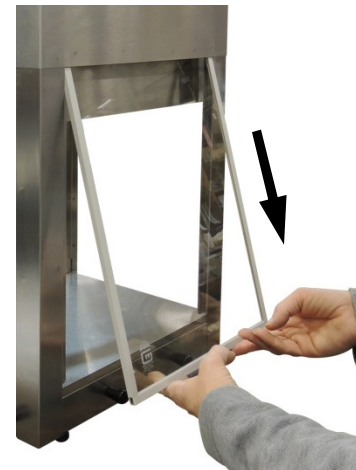
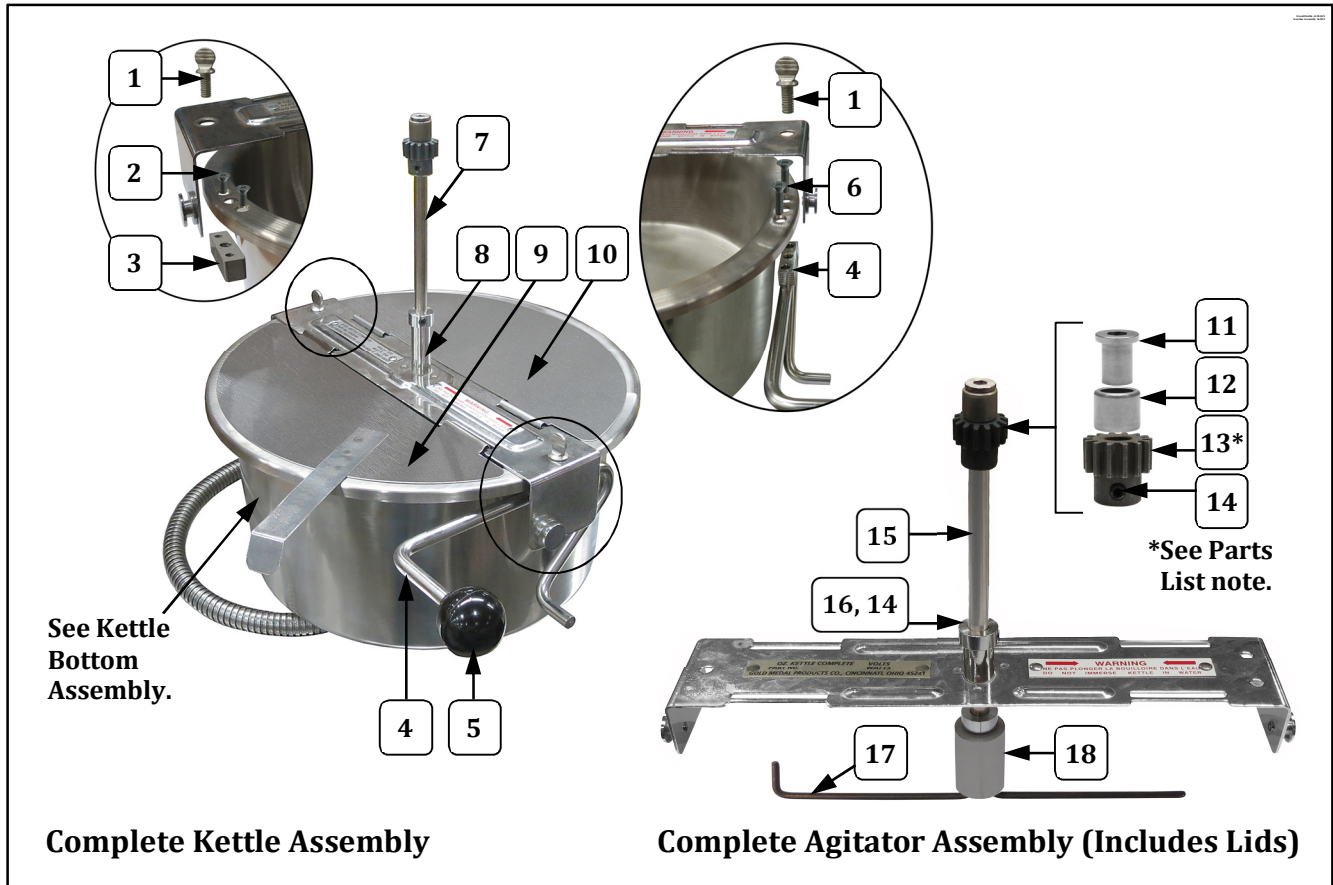

**Figure C** - Swing bottom of glass panel out, then lower it away from unit.

**General images shown for glass installation reference only.**



## 12/14 oz. Kettle Assembly (58014, 58014KC) – Agitator Assy. View



Item	Part Description	Part Number
		58014, 58014KC
1	1/4-20 X 1/2 THUMB SCREW	61059
2	8-32 X 3/8 FL HD PH MS	20065
3	KETTLE & SHELL BLOCK	61013
4	DUMP HANDLE - BLOCK WELDMENT	88769
5	DUMP HANDLE KNOB	47110
6	8-32 X 1 FL HD PH MS	20068
7	LID & AGITATOR ASSY (Complete Assembly)	58016
8	KETTLE CROSSBAR ASSEMBLY	58015
9	FRONT KETTLE LID	47720
10	REAR KETTLE LID	47119
11	AGITATOR BEARING HUB	43434
12	NEEDLE BEARING	47106
13	SPUR GEAR KIT (Includes 2 gears with set screws. Always replace Agitator Spur Gear and Kettle Drive Motor Gear as a set.)	47059K
14	SET SCREW #10-32 X 3/16	41742
15	12/14 OZ. AGITATOR SHAFT	69712
16	SET COLLAR 5/16 ID 5/8 OD	46649
17	AGITATOR WEIGHT	69715
18	6 OZ. STIR ROD	69806

## 12/14 oz. Kettle Assembly (58014, 58014KC) – Kettle Bottom View

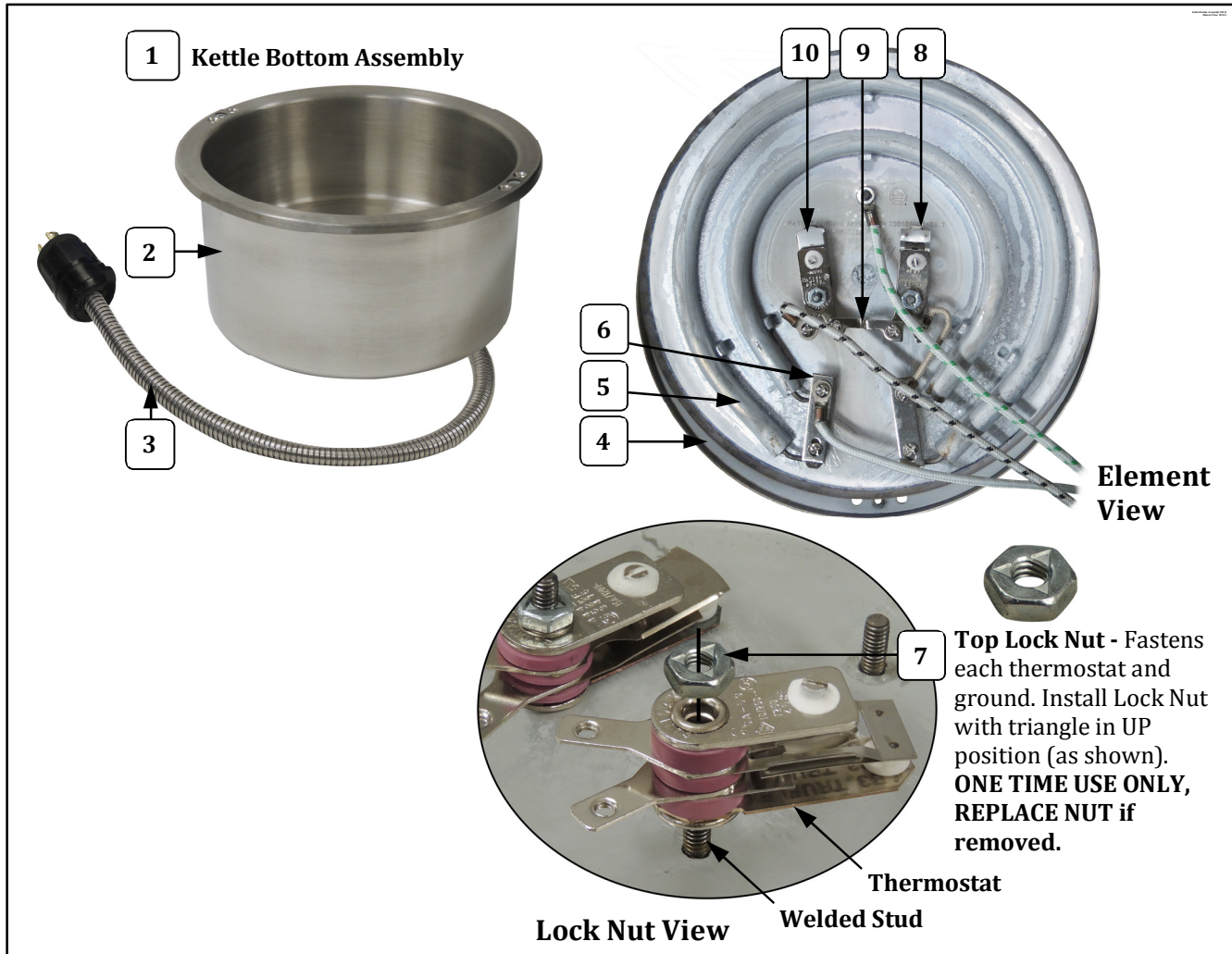

Item	Part Description	Part Number	Part Number
		58014	58014KC
1	12/14 OZ. KETTLE BOTTOM ASSEMBLY (includes parts listed below)	58012	58012KC
2	KETTLE SHELL	61017	61017
3	KETTLE LEAD ASSY	61226	61226
4	KETTLE GASKET	61012	61012
5	KETTLE INTEGRAL HTR 12/14	58011	58011
6	12/14OZ SHUNT BAR	77879	77879
7	8-32 TOP LOCK NUT (always replace if removed)	67943	67943
8	482°F THERMOSTAT (includes two 6-32 screws)	76708	
	450F THERMOSTAT (includes two 6-32 screws)		76089
9	THERMOSTAT SHUNT BAR	47193	47193
10	550°F THERMOSTAT (includes two 6-32 screws)	77108	
	525F THERMOSTAT (includes two 6-32 screws)		76702

## Cabinet Exterior – Front View

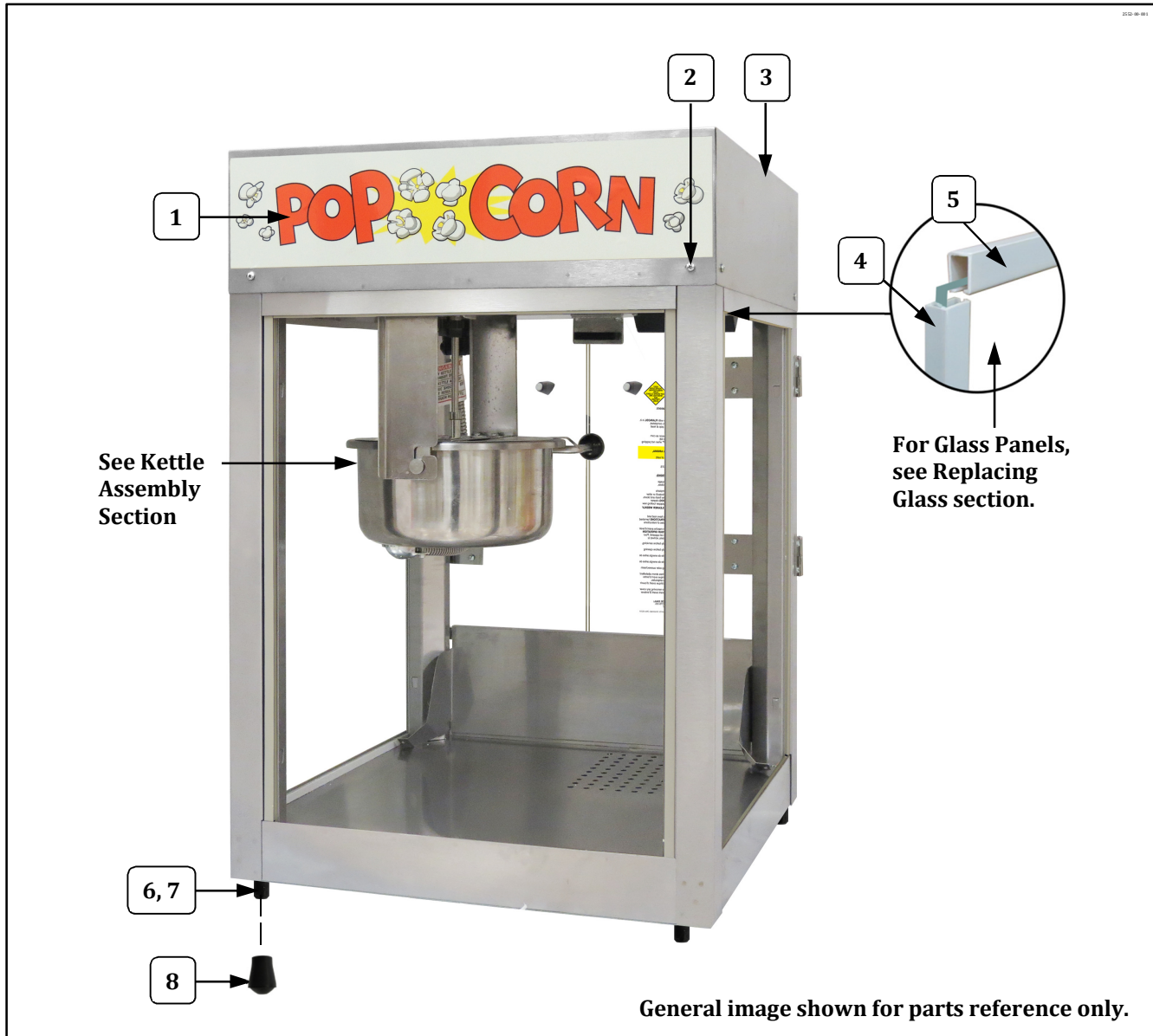

Item	Part Description	Part Number	
		2552	2552KC
1	DECAL, POPCORN	49777	
	GLASS DECAL PAPPYS		49158KC
2	8-32 X 3/8 SLT. HWH M/S	42044	42044
3	DOME WELDMENT	77769	77769
4	21 5/16" GLASS CHANNNEL (used on the side edges of the glass panels)	49844	49844
5	16 1/4" GLASS CHANNEL (used on the top and bottom edges of the glass panels)	74172	74172
6	GLIDE	47328	47328
7	10-24 X 3/4" HEX HEAD	41314	41314
8	CRUTCH TIP BLACK 70 DURO	49123	49123

## Cabinet Exterior – Rear View

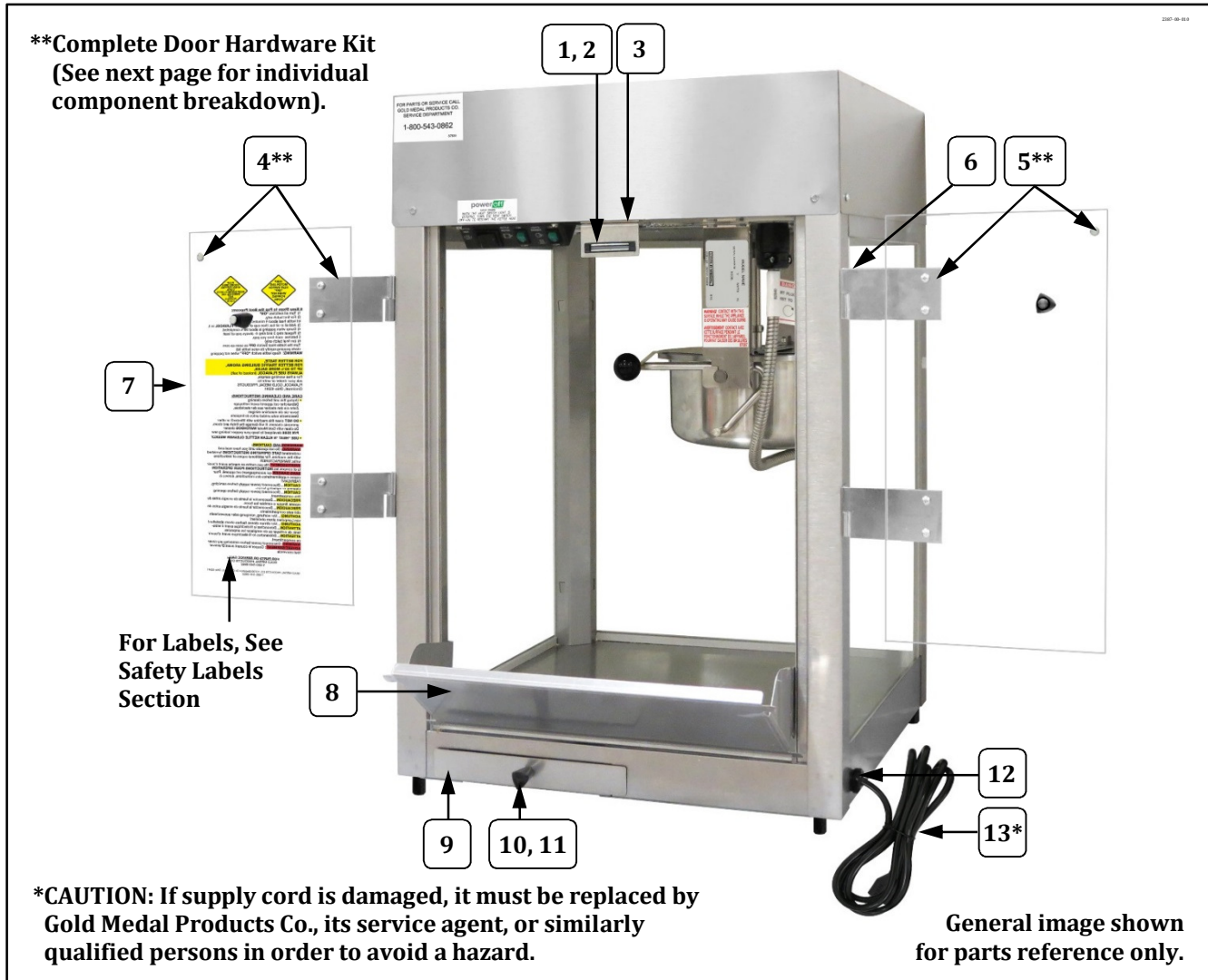

Item	Part Description	Part No.
1	MAGNETIC CATCH	47561
2	MAGNETIC CATCH BRACKET	41340
3	MAGNETIC BRACKET SHIM	38527
4**	COMPLETE LH DOOR HARDWARE KIT	47054
5**	COMPLETE RH DOOR HARDWARE KIT	47055
6	8-32 X 1/2 PHIL PAN M/S (fastens male hinges to the corner posts)	47141
7	DOOR	77774
8	DROP PANEL	77730
9	OLD MAID PAN	49100
10	LID LIFT KNOB	47120
11	8-32" X 3/8" PH PAN W/SEMS	42227
12	STRAIN RELIEF SR-7W-2	67060
13*	LEAD-IN CORD 15 AMP PLUG	87085

## Door Hardware Kits – Individual Component Breakdown

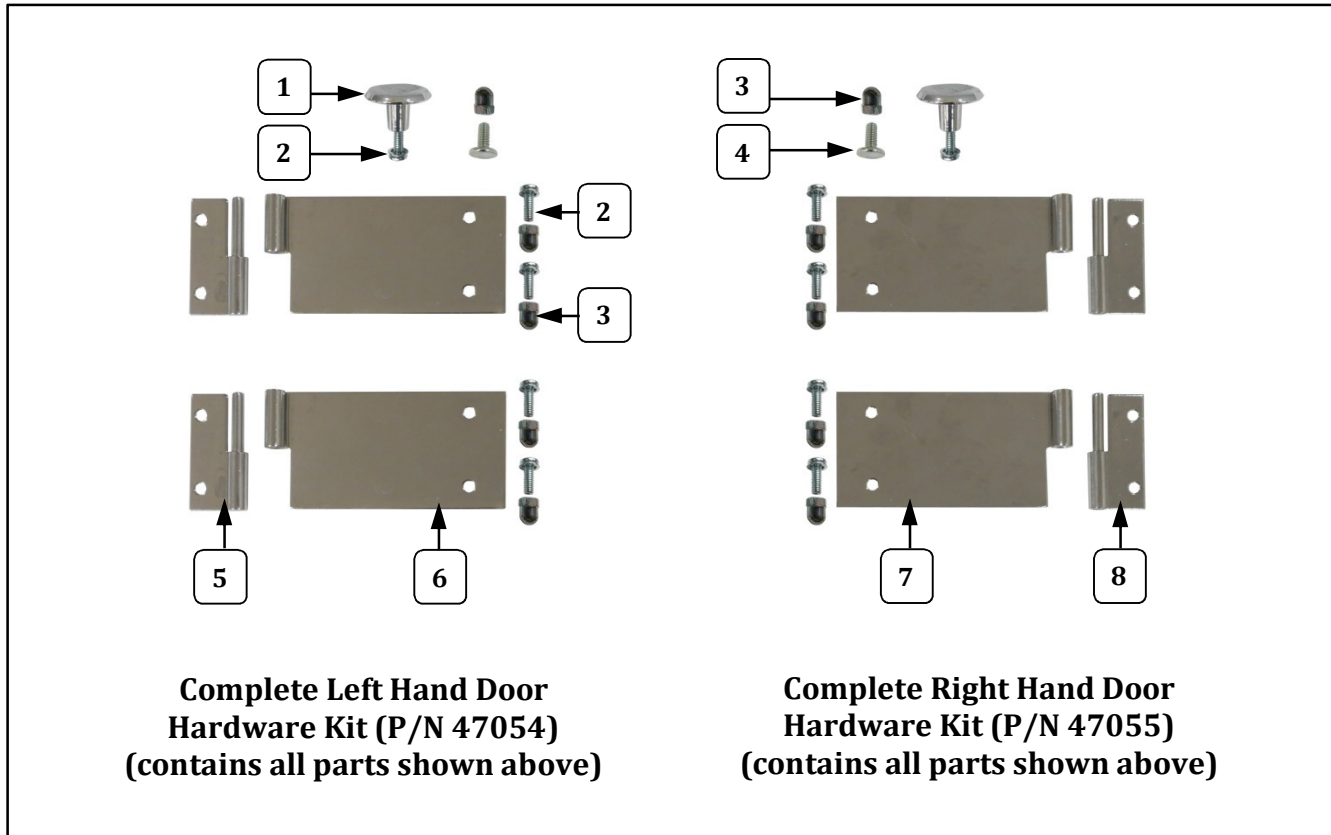

Item	Part Description	Part Number	
		47054	47055
1	DOOR KNOB	41013	41013
2	8-32 X 1/2 SCREWS PH PAN W/SEMS	47124	47124
3	ACORN NUT #8-32	47702	47702
4	TEE BOLT	75267	75267
5	MALE HINGE SHORT LEFT	41349	
6	FEMALE HINGE LONG LEFT	41352	
7	FEMALE HINGE LONG RIGHT		41351
8	MALE HINGE SHORT RIGHT		41350

## Cabinet Interior – Controls View

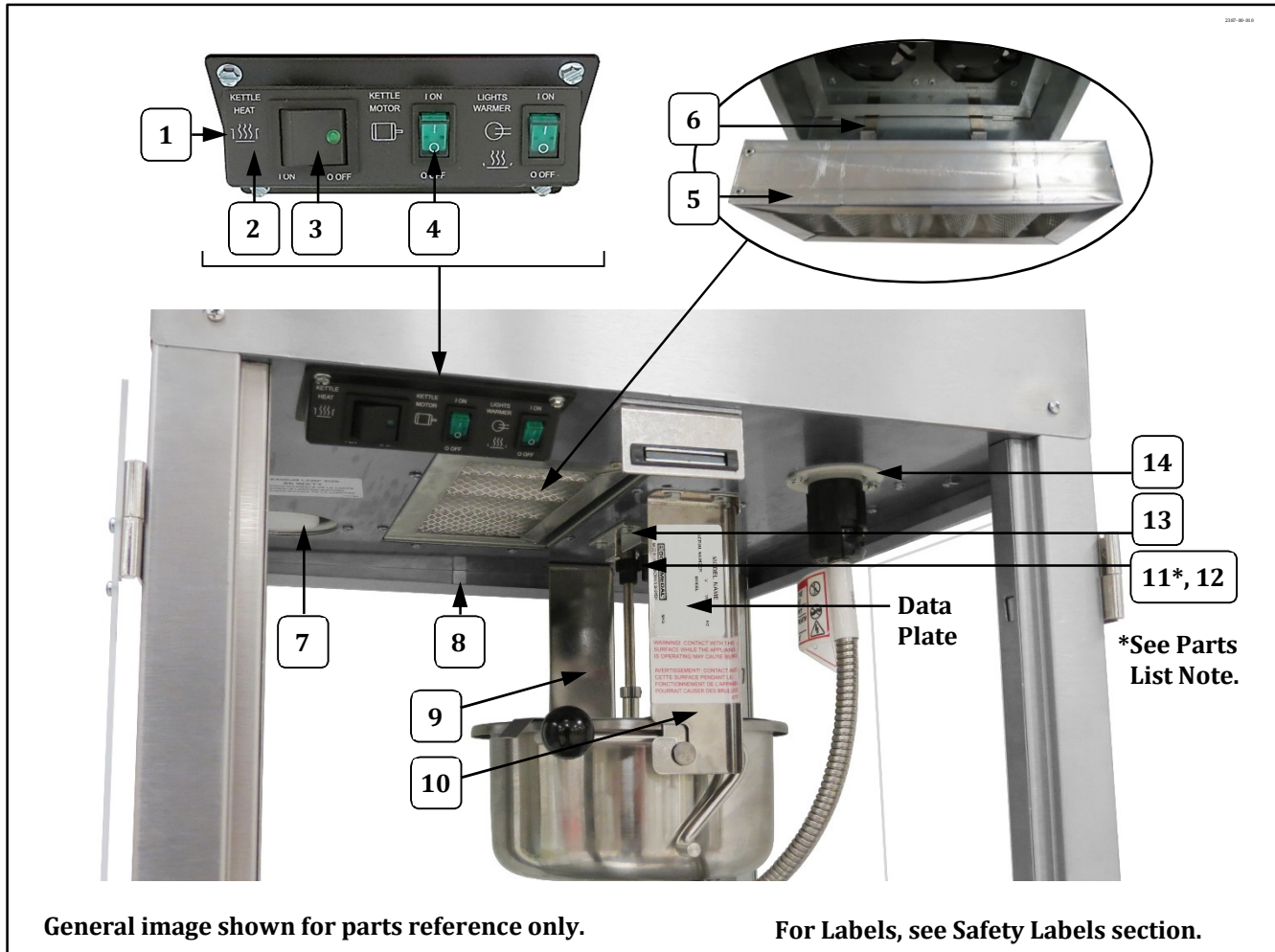

General image shown for parts reference only.

For Labels, see Safety Labels section.

Item	Part Description	Part No.
1	SMALL SWITCH BOX	48501
2	SMALL SWITCH LABEL	48502
3	GREEN LIGHTED ROCKER SWITCH	42798
4	DPST ROCKER SWITCH	42532
5	5 X 10 X 2 FILTER	69850
6	FILTER SPRING CLIP	62666
7	50 W FLOOD LIGHT COATED	42947
8	.5x.5x.1 MAGNET GLASS LOCK	51113
9	REAR HANGER ARM	61050
10	FRONT HANGER ARM	61049
11*	SPUR GEAR KIT (includes 2 gears with set screws. Always replace Agitator Spur Gear <u>and</u> Kettle Drive Motor Gear as a set.)	47059K
12	SET SCREW #10-32 X 3/16	41742
13	GEAR BLOCK	67194
14	L5-15R 15A RECEPTACLE	49330

## Cabinet Bottom – Corn Pan Element View

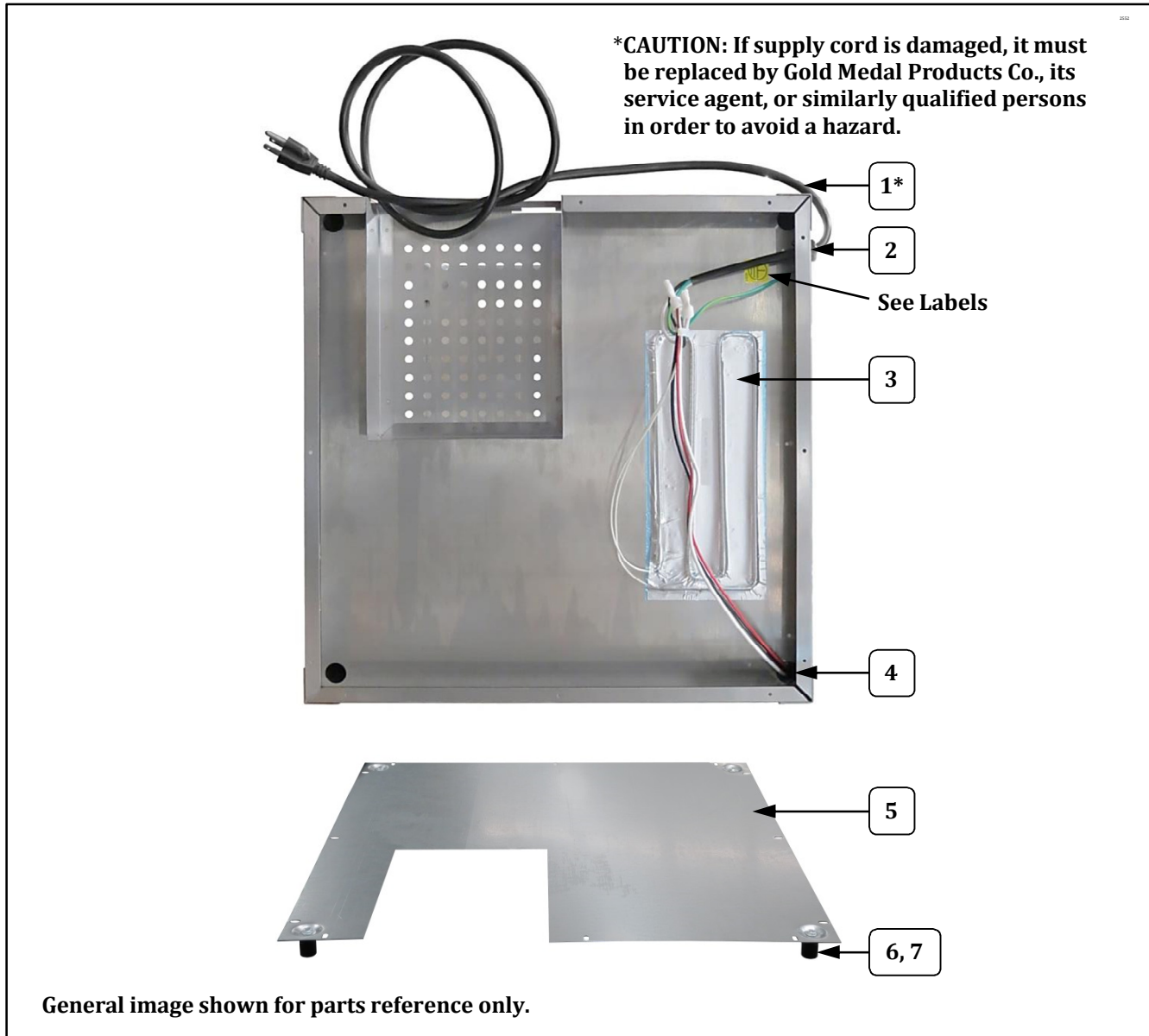

Item	Part Description	Part No.
1	LEAD-IN CORD 15 AMP PLUG	87085
2	STRAIN RELIEF	67060
3	120V FOIL HEATER, 20 WATT	40557
4	.875 SNAP BUSHING	45396
5	BOTTOM COVER	49838
6	GLIDE	47328
7	10-24 X 3/4 HEX HD	41314

## Motor Plate Assembly

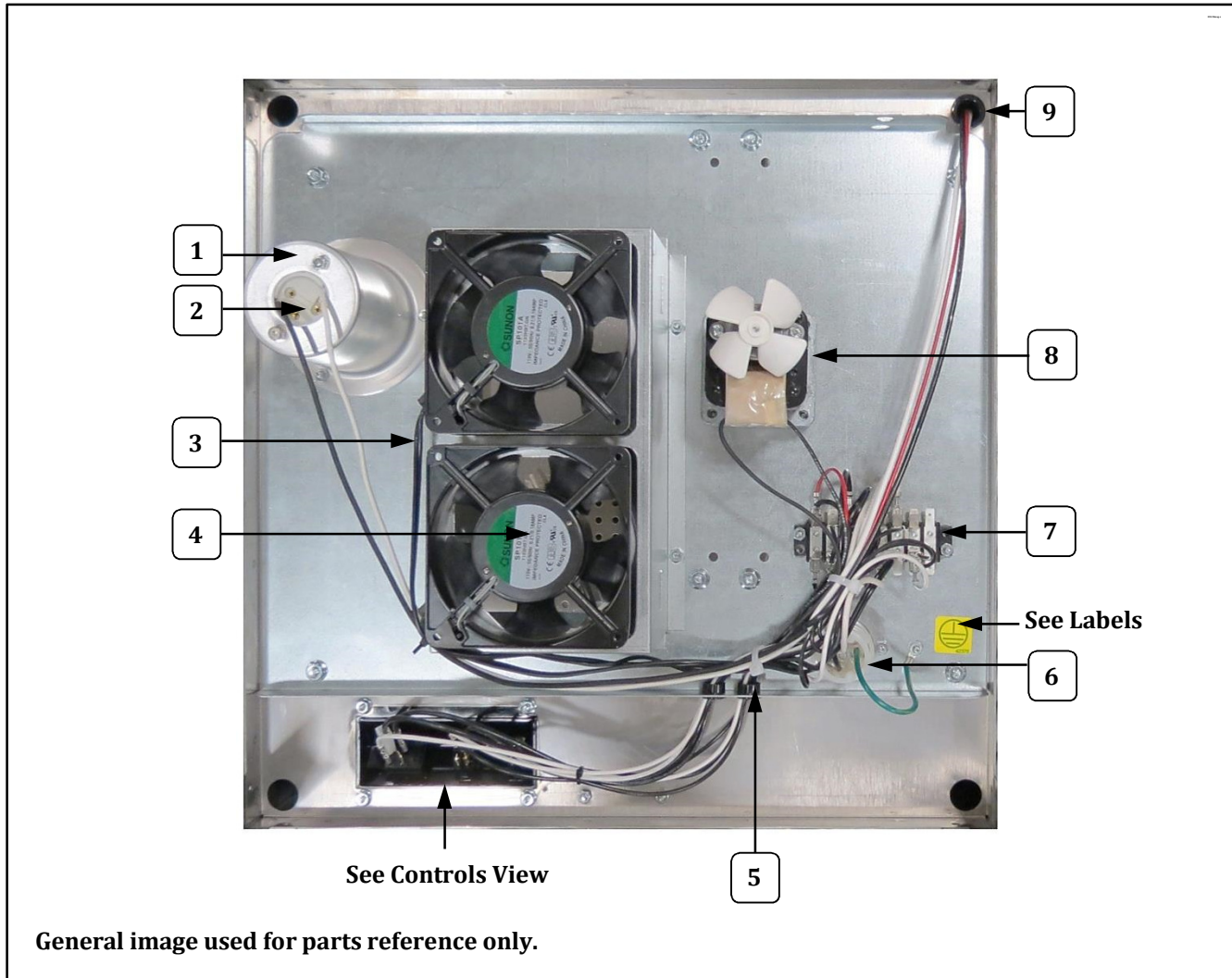

Item	Part Description	Part No.
1	LIGHT SHIELD CONICAL	40589
2	LAMP HOLDER	47047
3	BLOWER PLUG AND CORD	47199
4	EXHAUST BLOWER	48018
5	BUSHING, SNAP .625 IN	47282
6	KETTLE RECEPTACLE	49330
7	TERMINAL BLOCK	47208
8	KETTLE DRIVE MOTOR 120V	47038
9	.875 SNAP BUSHING	45396



# Safety Labels

**1** →

**2** →

**3** →

**WARNING! CONTACT WITH THIS SURFACE WHILE THE APPLIANCE IS OPERATING MAY CAUSE BURNS**

**AVERTISSEMENT! CONTACT AVEC CETTE SURFACE PENDANT LE FONCTIONNEMENT DE L'APPAREIL POURRAIT CAUSER DES BRULURES**

### Unit Labels

**4** →

### Kettle Lead In Label

**5** →

  

### Power Cord Labels

Item	Part Description	Part No.
1	UNIVERSAL POPPER DECAL	41019
2	MAIN GROUND LABEL	42375
3	SURFACE CONTACT WARNING	87087
4	CONDUIT WARNING LABEL	82840
5	CORD WARNING LABEL	68720



## Accessories

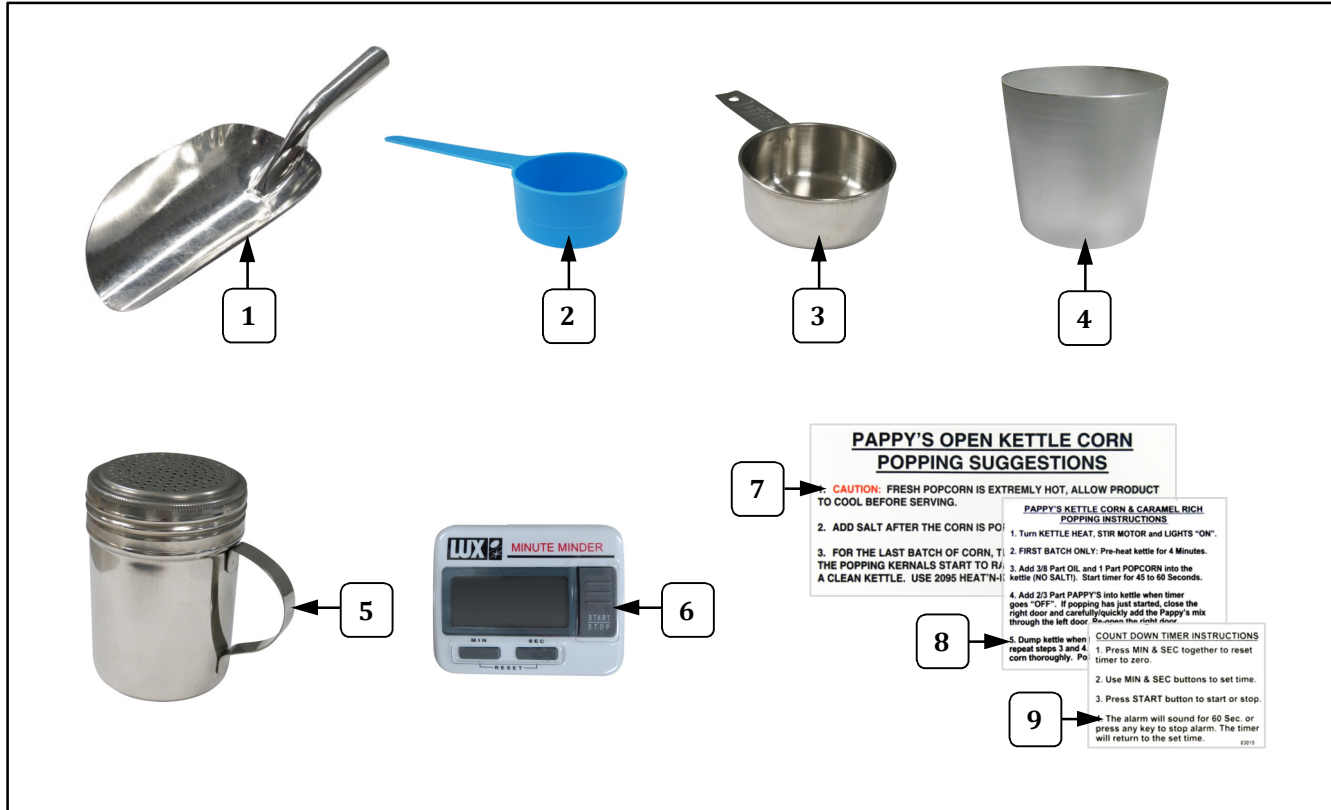

Item	Part Description	Part Number	
		2552	2552KC
1	STAMPED ALUMINUM SCOOP	2071	2071
2	14.7 CC MEASURE	47679	47679
3	1/2 CUP MEASURE	47149	47149
4	12 OZ CORN MEASURE	47148	47148
5	SALT SHAKER		63016
6	TIMER, LCD RESETABLE		63012
7	PAPPYS POPPING SUGG LABEL		63011
8	LABEL, PAPPY'S INSTRUCT		63014
9	LABEL, PAPPY'S TIMER		63015



# Wiring Diagram

## Model 2552, 2552KC

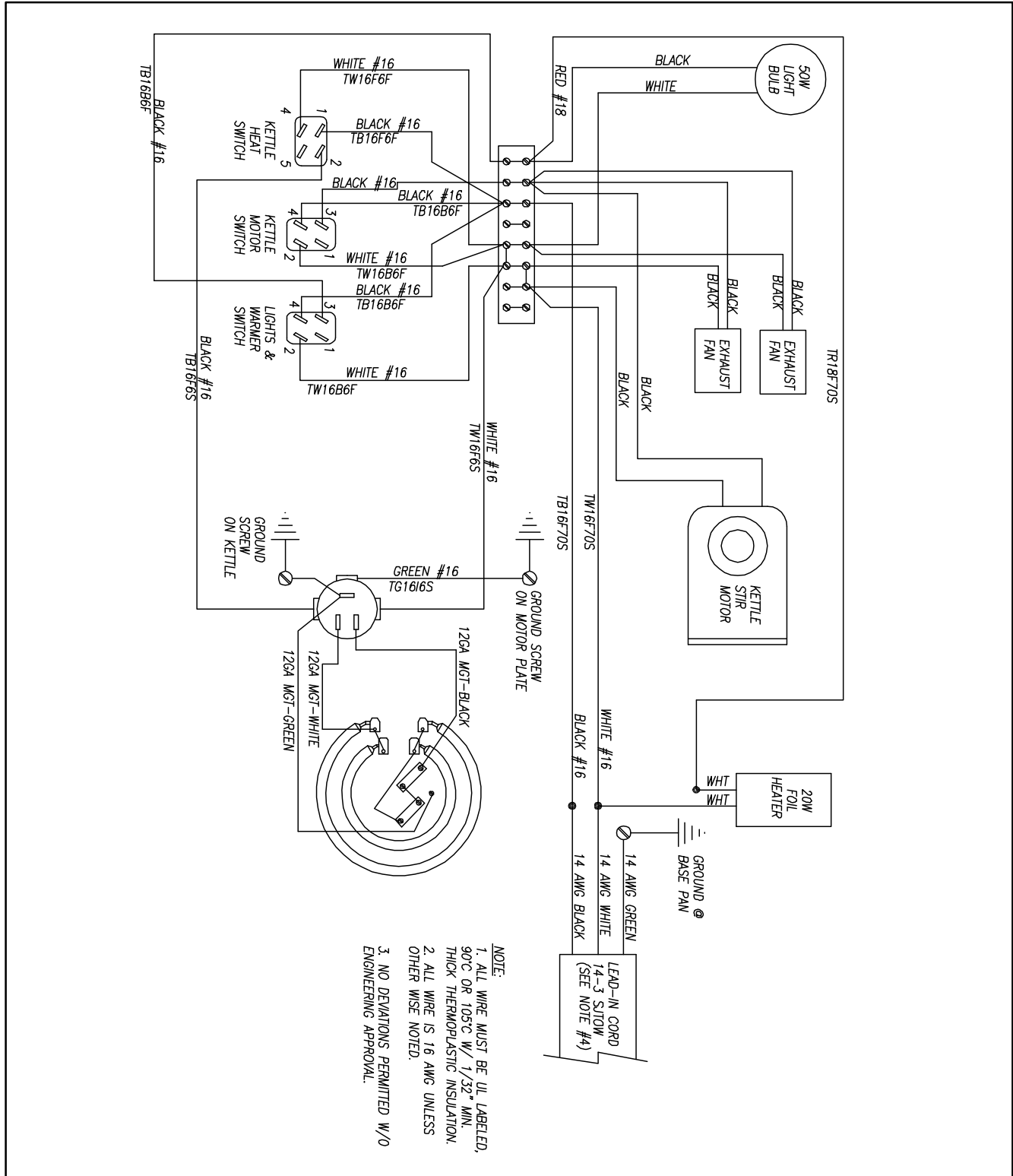



## WARRANTY

Gold Medal Products Co. warrants to the original purchaser each item of its manufacture to be free of defects in workmanship and material under normal use and service. Gold Medal Products Co.'s obligation under this warranty is limited solely to repairing or replacing parts, f.o.b. Cincinnati, Ohio, which in its judgment are defective in workmanship or material and which are returned, freight prepaid, to its Cincinnati, Ohio factory or other designated point. Except for "Perishable Parts" on specific machines, the above warranty applies for a period of two (2) years from the date of original sale to the original purchaser of equipment when recommended operating instructions and maintenance procedures have been followed. These are packed with the machine. Parts warranty is two (2) years, labor is six (6) months.

THIS WARRANTY IS IN LIEU OF ALL OTHER WARRANTIES EXPRESSED OR IMPLIED, AND OF ALL OTHER OBLIGATIONS OR LIABILITIES ON OUR PART, INCLUDING THE IMPLIED WARRANTY OF MERCHANTABILITY. THERE ARE NO WARRANTIES WHICH EXTEND BEYOND THE DESCRIPTION ON THE FACE HEREOF. In no event shall Gold Medal Products Co. be liable for special, incidental or consequential damages. No claim under this warranty will be honored if the equipment covered has been misused, neglected, damaged in transit, or has been tampered with or changed in any way. No claim under this warranty shall be honored in the event that components in the unit at the time of the claim were not supplied or approved by Gold Medal Products Co. This warranty is effective only when electrical items have been properly attached to city utility lines only at proper voltages. This warranty is not transferable without the written consent of Gold Medal Products Co.

The term "Original Purchaser" as used in this warranty shall be deemed to mean that person, firm, association, or corporation who was billed by the GOLD MEDAL PRODUCTS CO., or their authorized distributor for the equipment.

THIS WARRANTY HAS NO EFFECT AND IS VOID UNLESS THE ORIGINAL PURCHASER FIRST CALLS GOLD MEDAL PRODUCTS CO. AT 1-800-543-0862 TO DISCUSS WITH OUR SERVICE REPRESENTATIVE THE EQUIPMENT PROBLEM, AND, IF NECESSARY, FOR INSTRUCTIONS CONCERNING THE REPAIR OR REPLACEMENT OF PARTS.

*NOTE: This equipment is manufactured and sold for commercial use only.*



**GOLD MEDAL<sup>®</sup> PRODUCTS CO.**

10700 Medallion Drive, Cincinnati, Ohio 45241-4807 USA

[gmpopcorn.com](http://gmpopcorn.com)

Phone: (800) 543-0862      Fax: (800) 542-1496  
(513) 769-7676              (513) 769-8500